

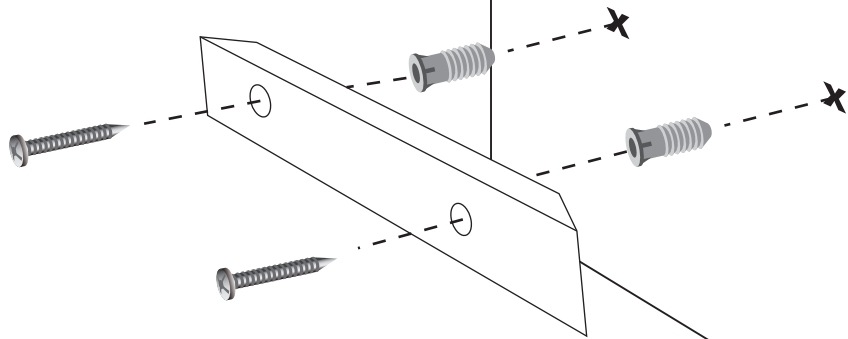

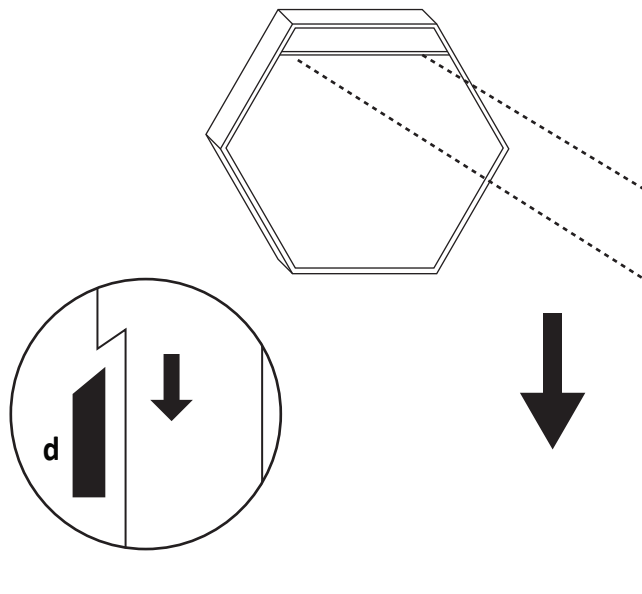

STEP - 1



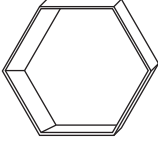

STEP - 2



PART LIST

PART NO.	PART PHOTOGRAPH	PART NAME	QUANTITY
a			1
b			1
c			1
d			3

ASSEMBLING TOOLS

1			
2			
3			

Choosing screws and plugs are customers own responsibility.