

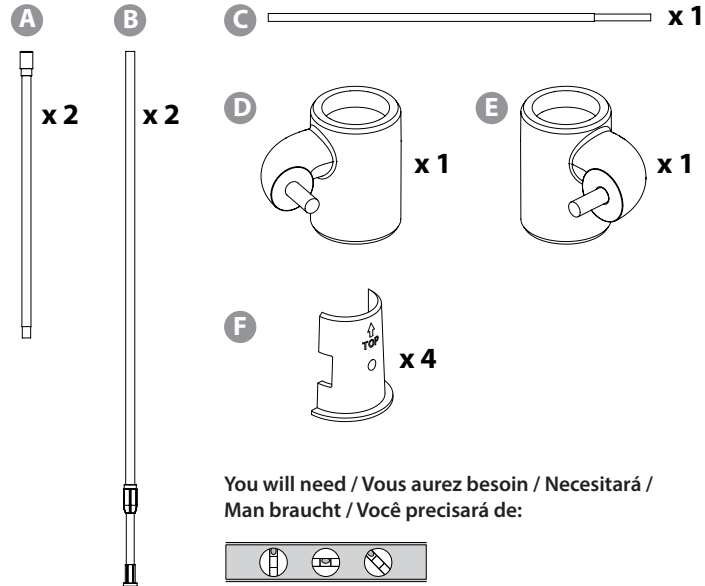

**ANYWHERE**  
 Tension Rod System  
 Système de tringle à tension  
 Sistema de barra de tensión  
 Spannstangensystem  
 Varão com sistema de tensão  
 umbra.com

## PACKAGE CONTENTS

Contenu de l'emballage / Contenido del empaque / Packungsinhalt /  
 Conteúdo da embalagem



- EN** Questions, problems, missing parts? Call our customer service at 1 800 387 5122 or email: info@umbra.com
- FR** Des questions? Des difficultés? Il vous manque des pièces? Appelez notre service à la clientèle au 1 800 387 5122 / email: info@umbra.com
- ES** ¿Preguntas? ¿Problemas? ¿Faltan piezas? Comuníquese con nuestro servicio al cliente en el +31 (0)36 549 5422 / email: info@umbra.com
- DE** Fragen, Probleme, fehlende Teile? Bitte kontaktieren Sie unseren Kundenservice unter der Rufnummer +31(0) 36 549 5422 / email: info@umbra.com
- PT** Dúvidas, problemas, peças faltando? Ligue para o nosso Atendimento ao Cliente +55 11 24765629 / email: info@umbra.com

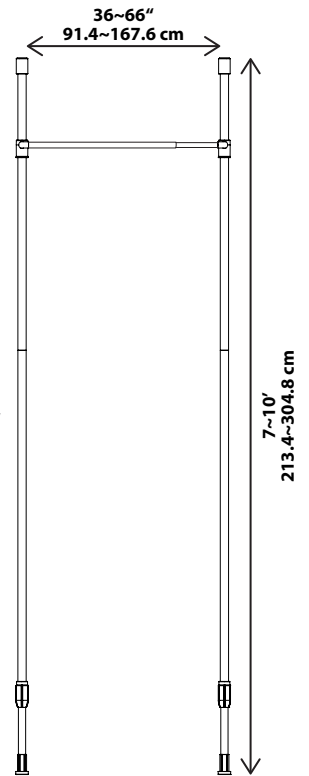

## PRE-INSTALLATION SET UP

Montage pré-installation / Configuración previa a la instalación /  
 Installationsvorbereitung / Montagem pré-instalação

Adjust brackets (F) to determine the height of horizontal rod (C).  
 Ajuster les supports (F) pour déterminer la hauteur de la tringle horizontale (C).  
 Ajuste los soportes (F) para determinar la altura de la barra horizontal (C).  
 Halterungen (F) einstellen, um Höhe der horizontalen Stange (C) zu bestimmen.  
 Ajuste os suportes (F) para determinar a altura do varão horizontal (C).

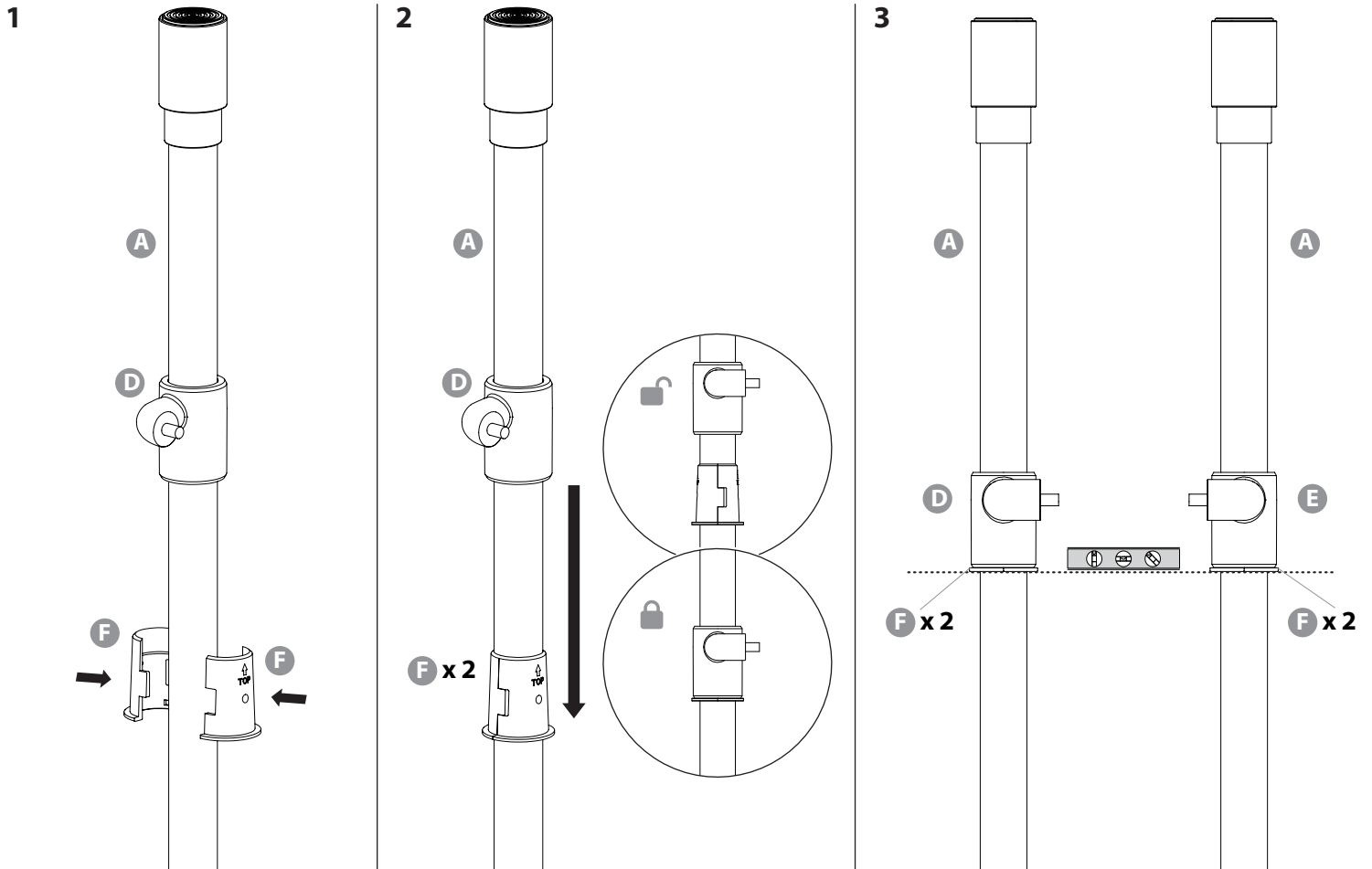

# INSTALL

Montage / Instalar / Montieren

4

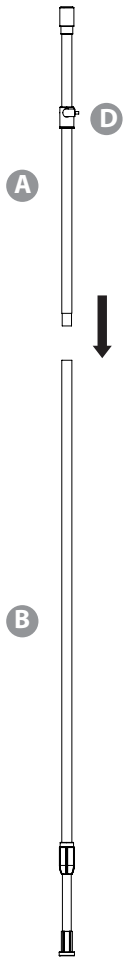

5

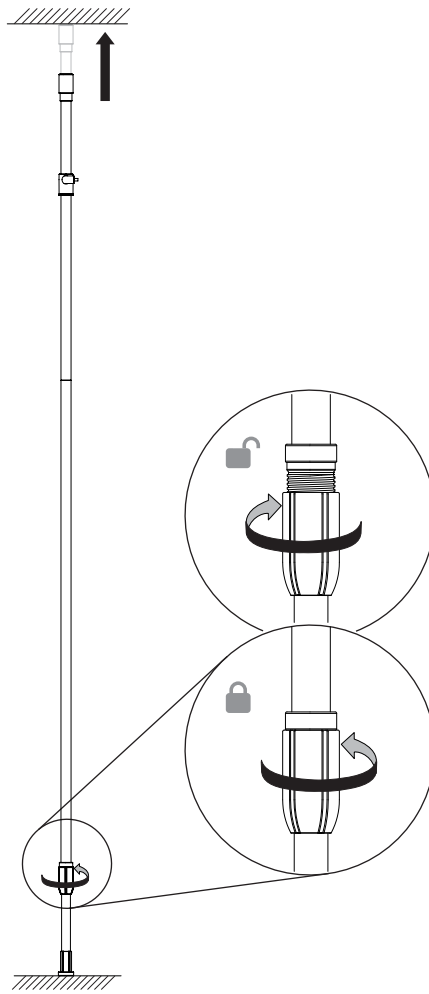

6

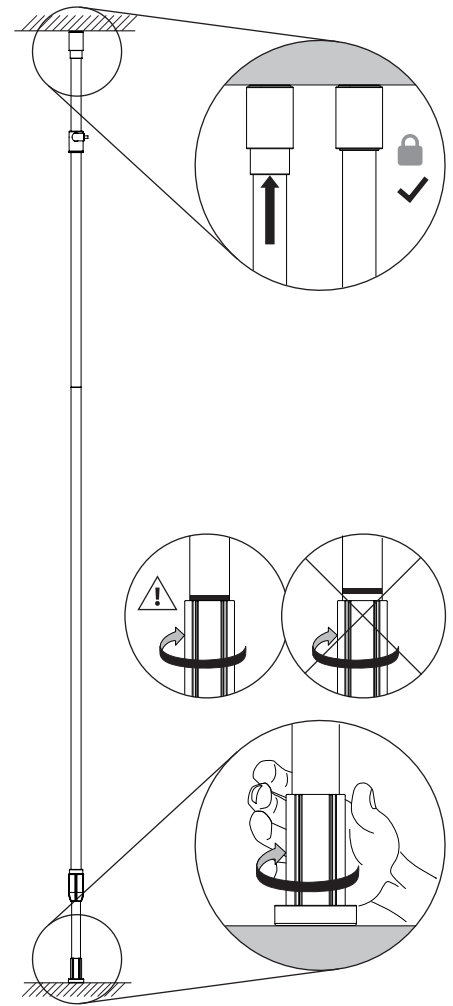

7

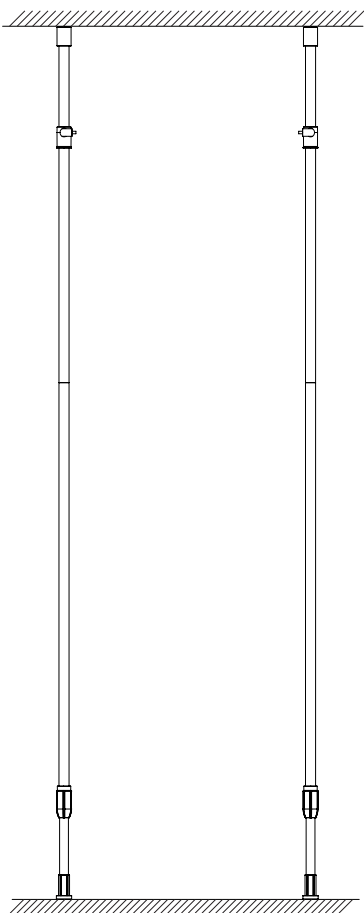

8

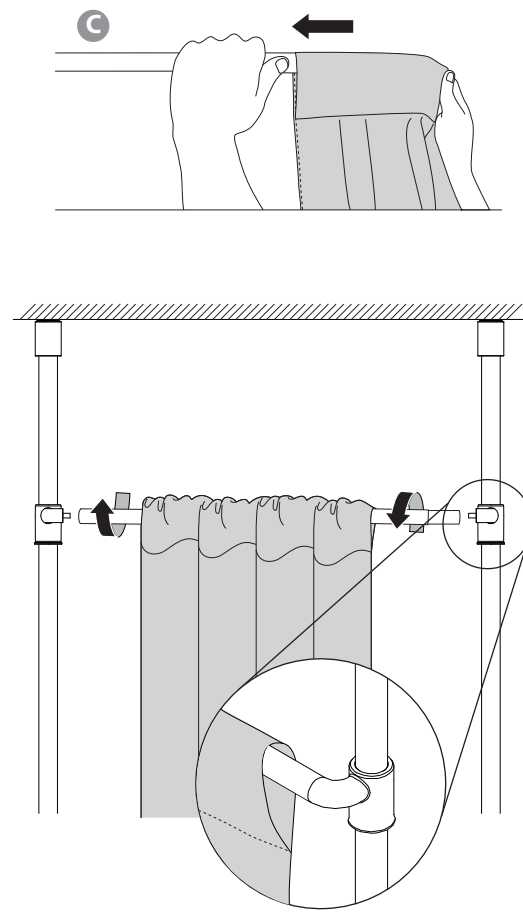

9

