

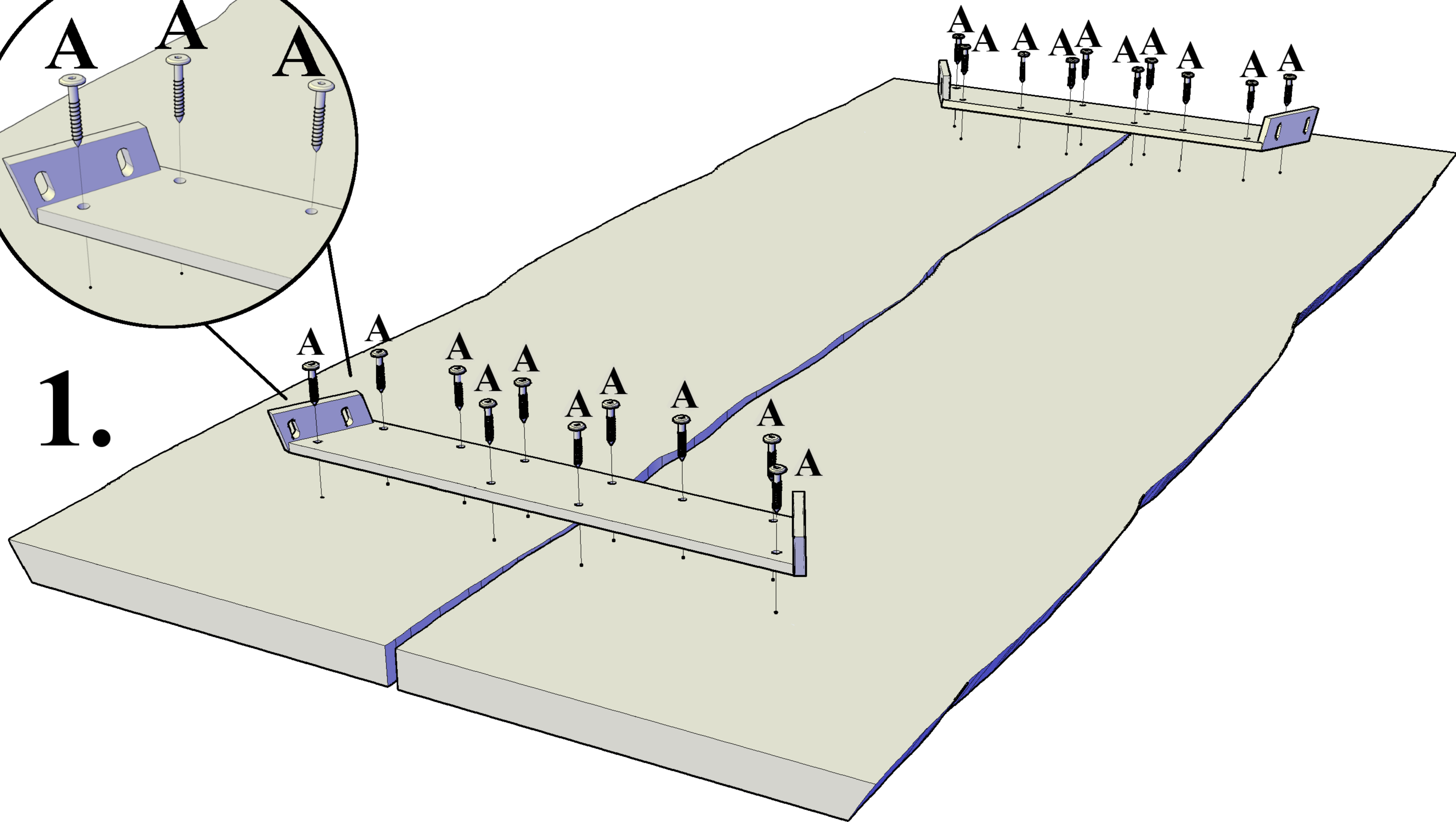

1.

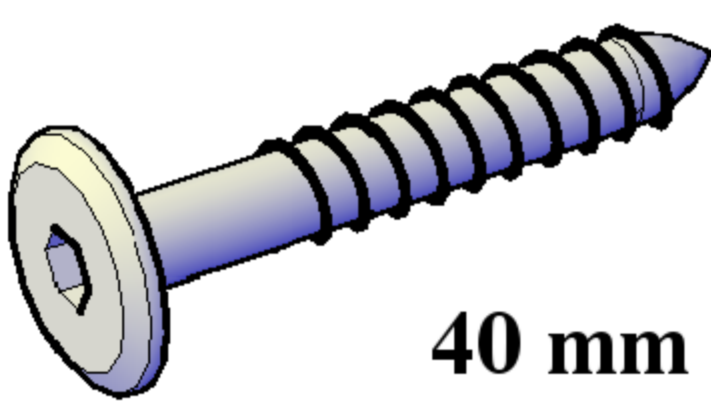
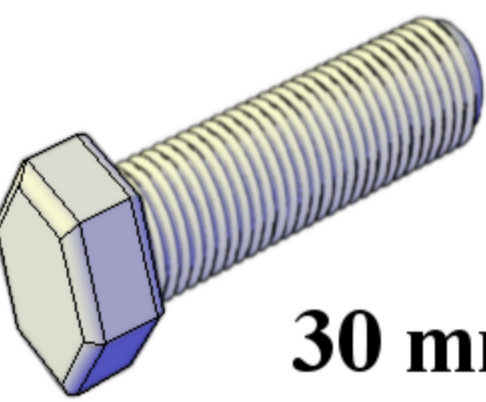

A  40 mm **x20**

B  30 mm **x8**

C  **x8**

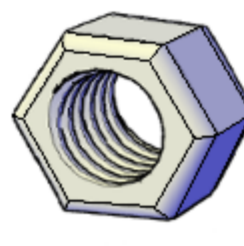
D  **x8**

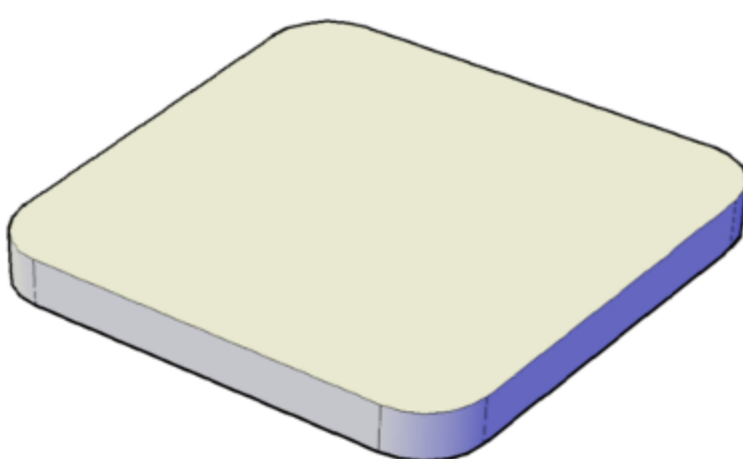
E  **x4**

2.

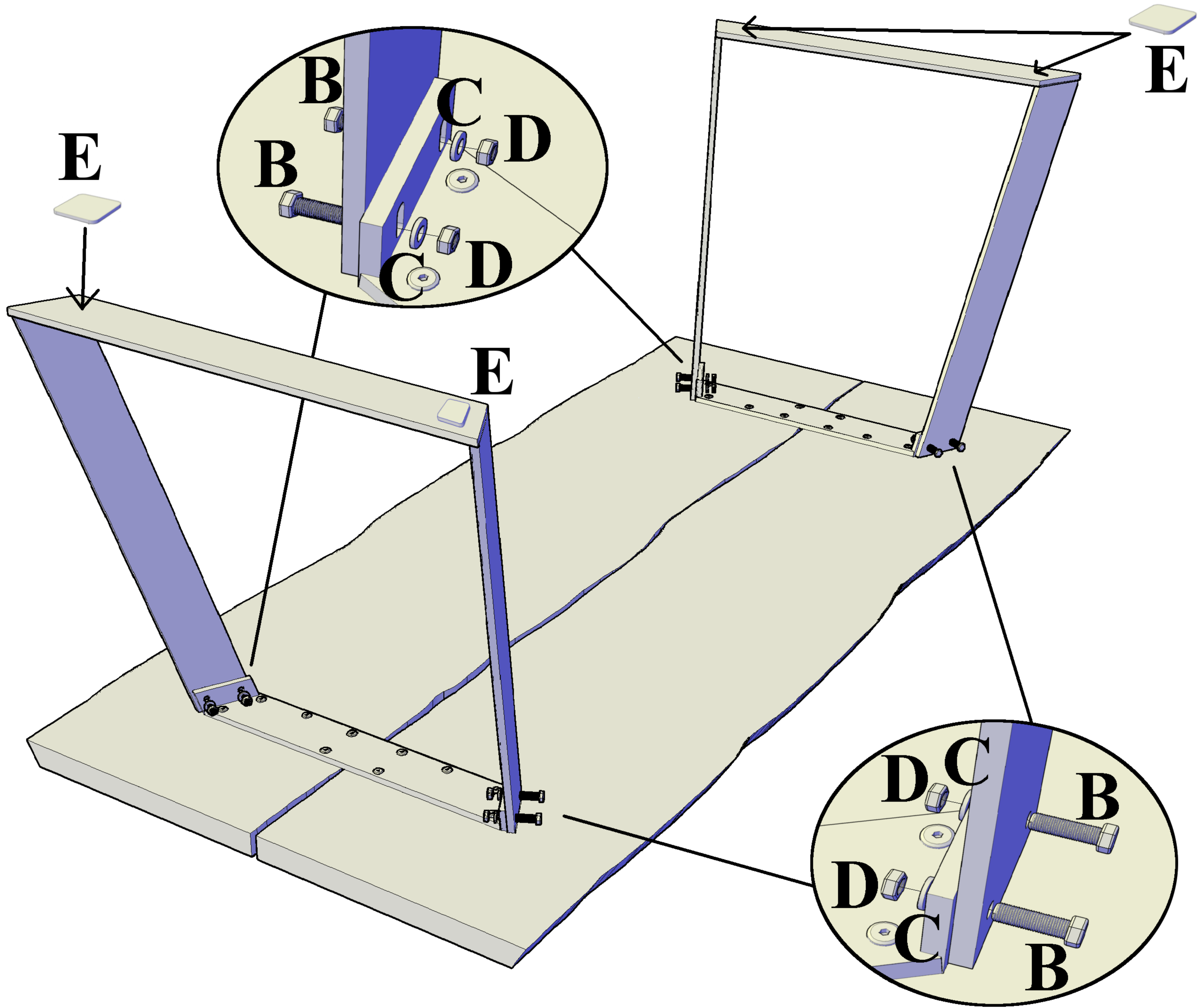

3.

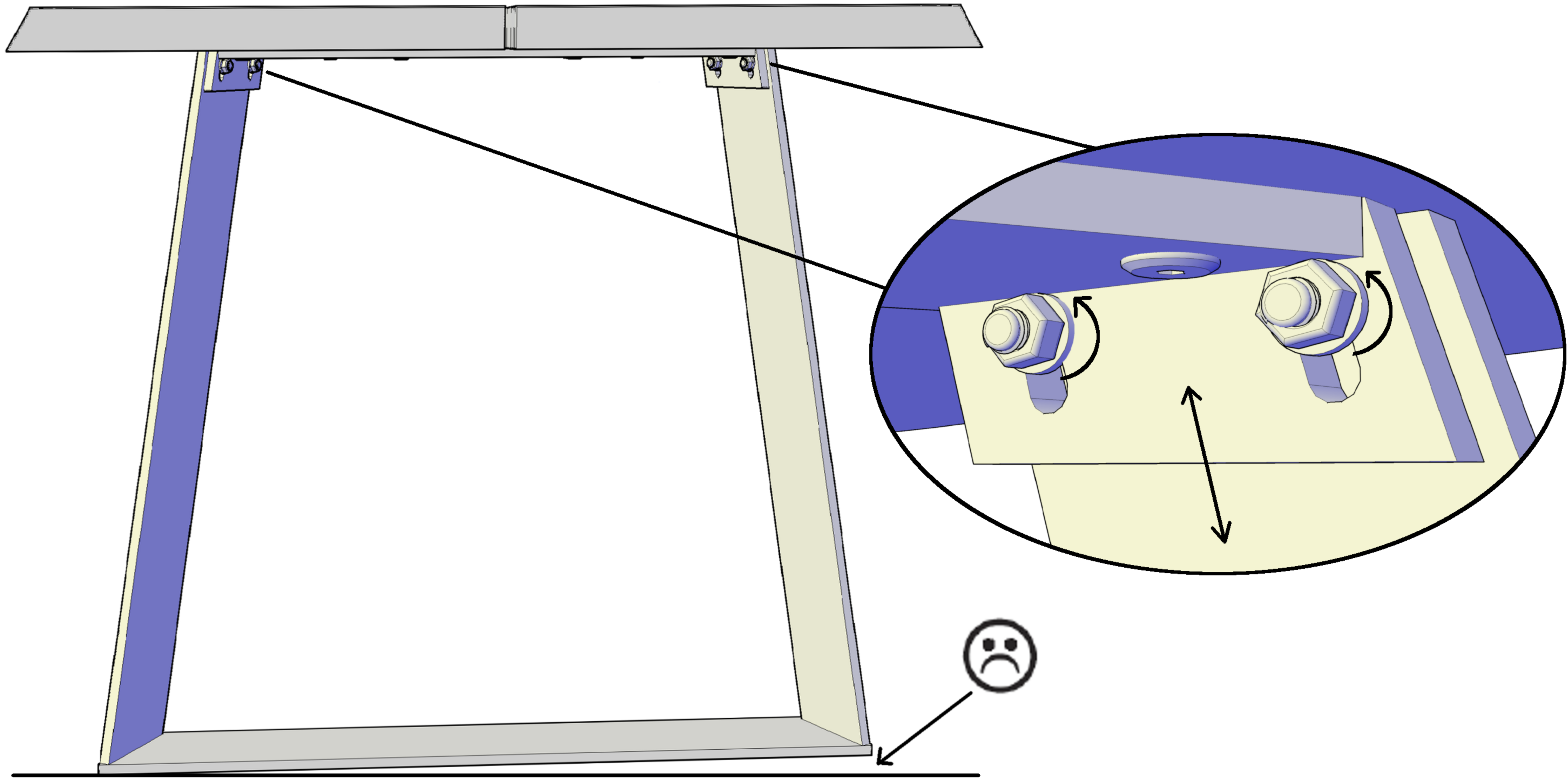

4.

