















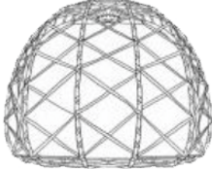







6465929 Skara riipputuoli 2-istuttava telineellä luonnonväri

6465936 Skara riipputuoli 2-istuttava telineellä taupe



Parts List

											
A-left	A-right	B	2	C	4	D	1	E	1	F	1
						reinforcement 					
G	1	H	1	I	1	J	4	L	2		
height adjuster 											
N	4	O	2	P	2	Q	2				
M-6 	M-6 		M-8 								
M-8 	R	2	S	1	M-8,60mm	2	M-8,50mm	4			
											
M-8,20mm	4	M-6,40mm	4	M-6,50mm	6						

Step 1:

Screw the 4 height adjusters (N) into the ends of the 4 support legs (C)

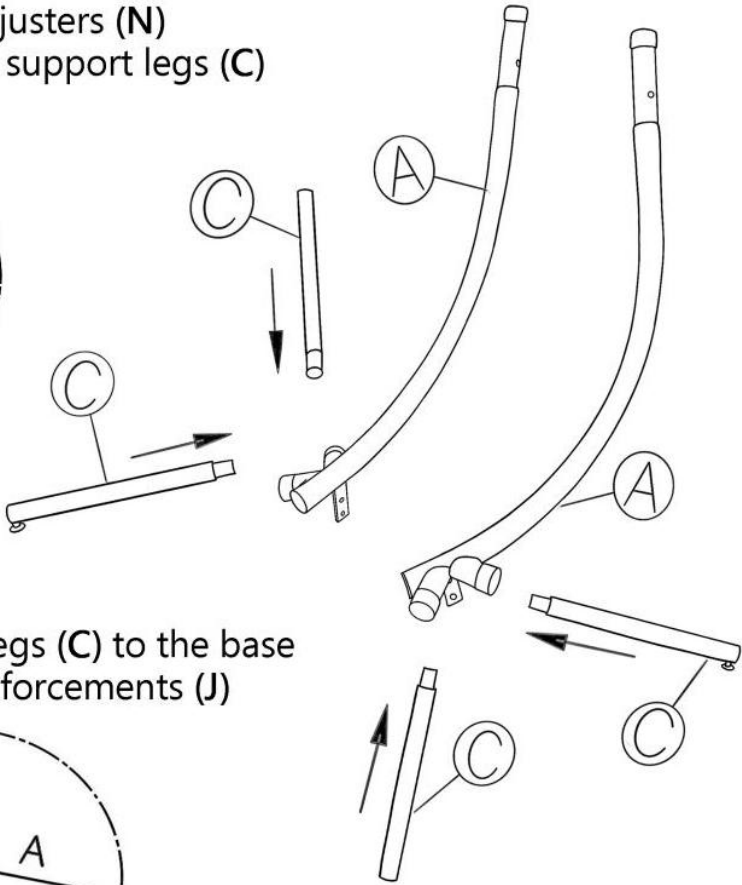
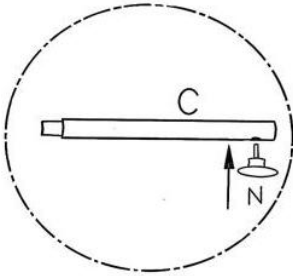

Step 2:

Fasten the 4 support legs (C) to the base frame (A) with the reinforcements (J)

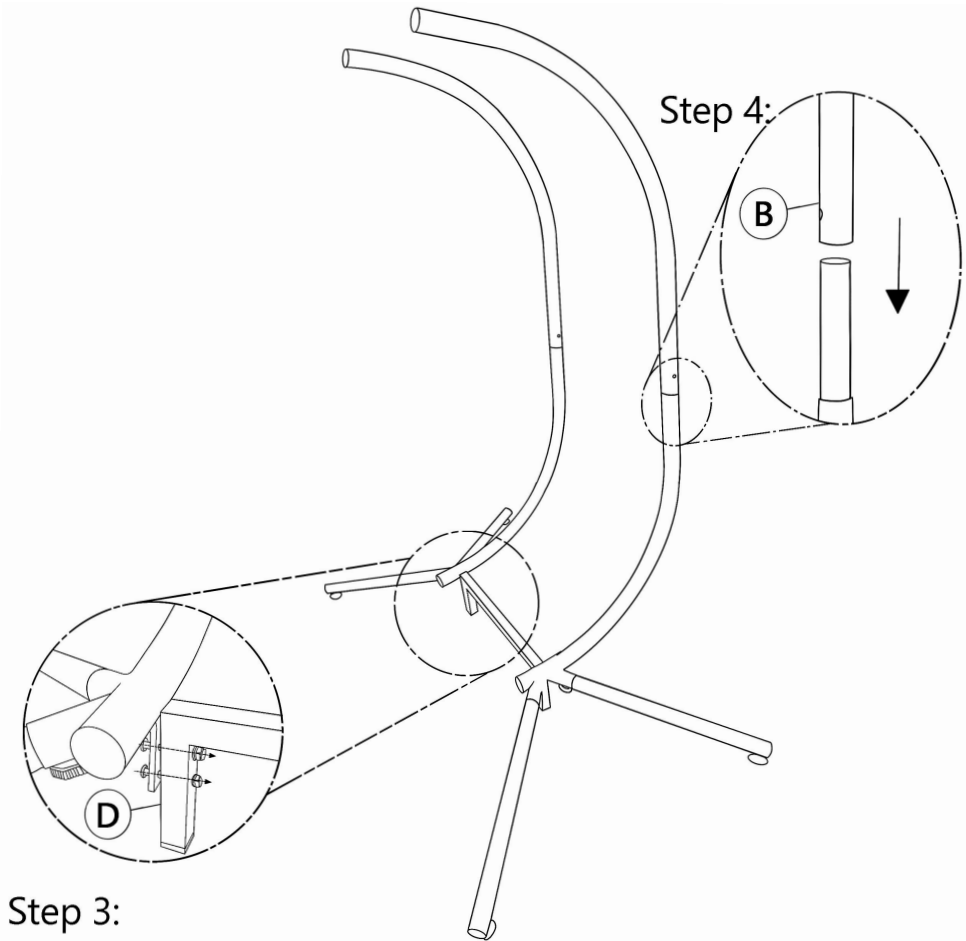
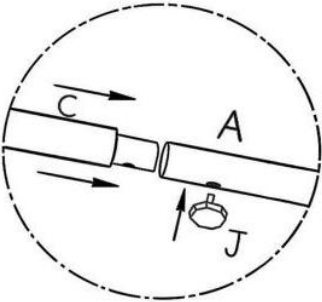

Step 3:

Fasten the Accessory D to the base frame (A) with the crews (M-8, 50mm)

Step 5:
Screw (M-8,60mm) to secure
B and E together

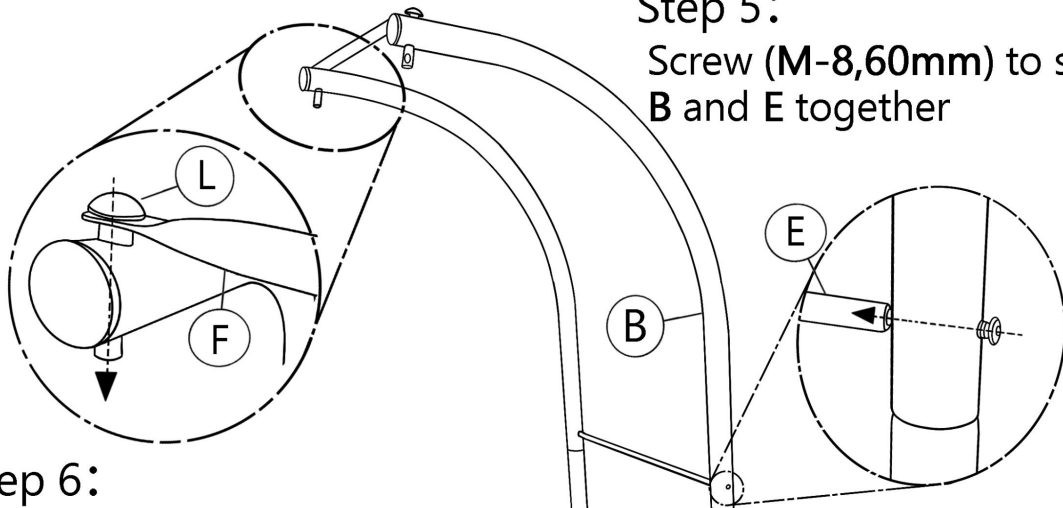

Step 6:
Use L secure B and F together

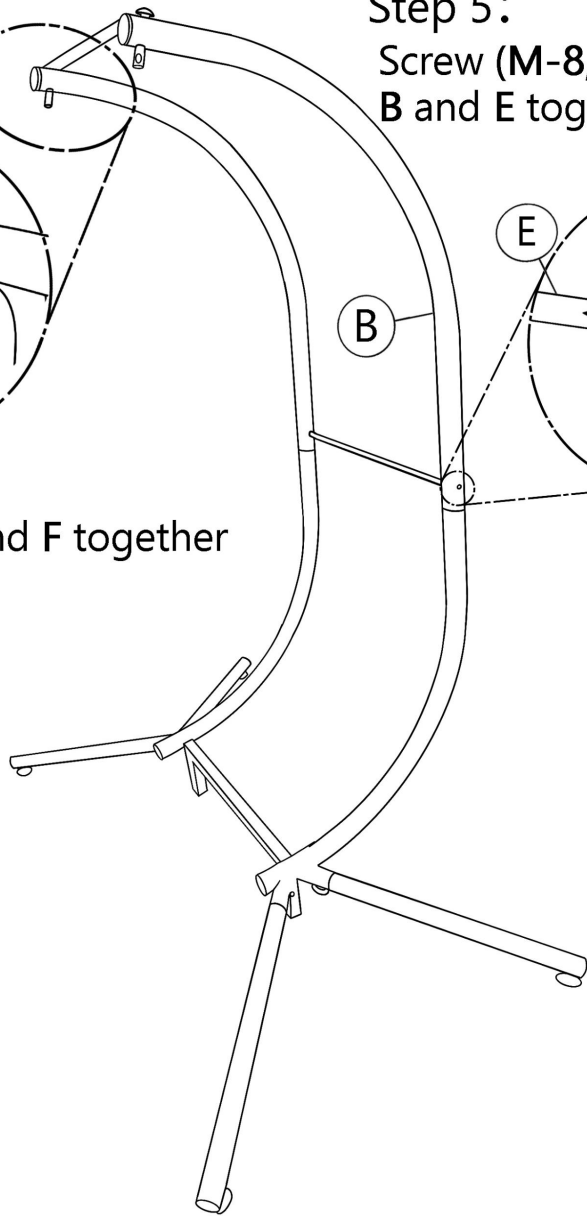

Step 7: Simply flip the chair base (H) over

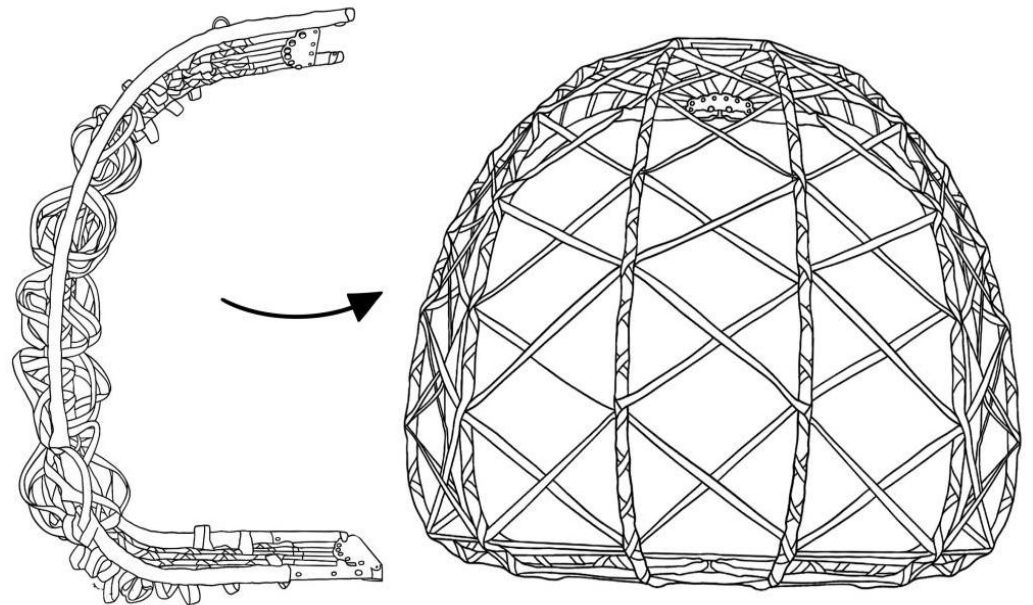

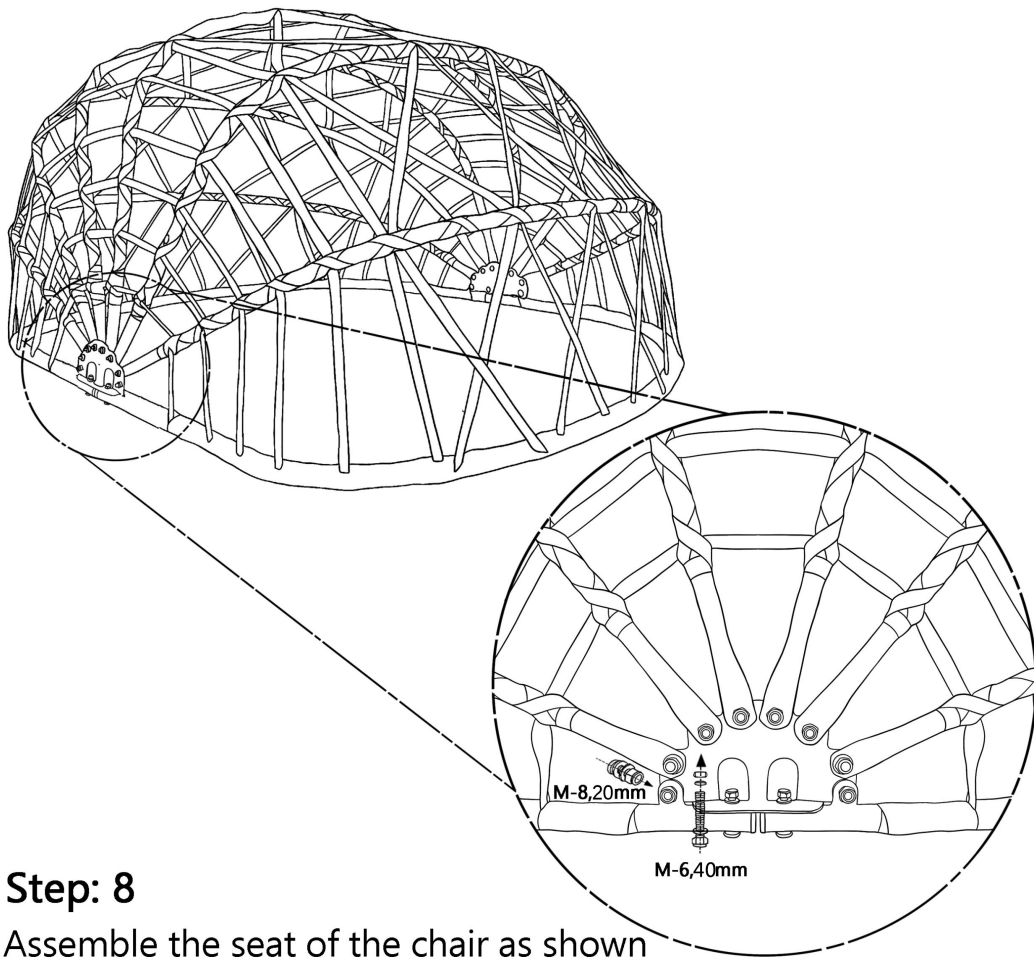

Step: 8

Assemble the seat of the chair as shown

Installation of 2 (M-8,20mm), 2 (M-6,40mm)

Step 9:

Installation of 2 (M-8,20mm)
2 (M-6,40mm)

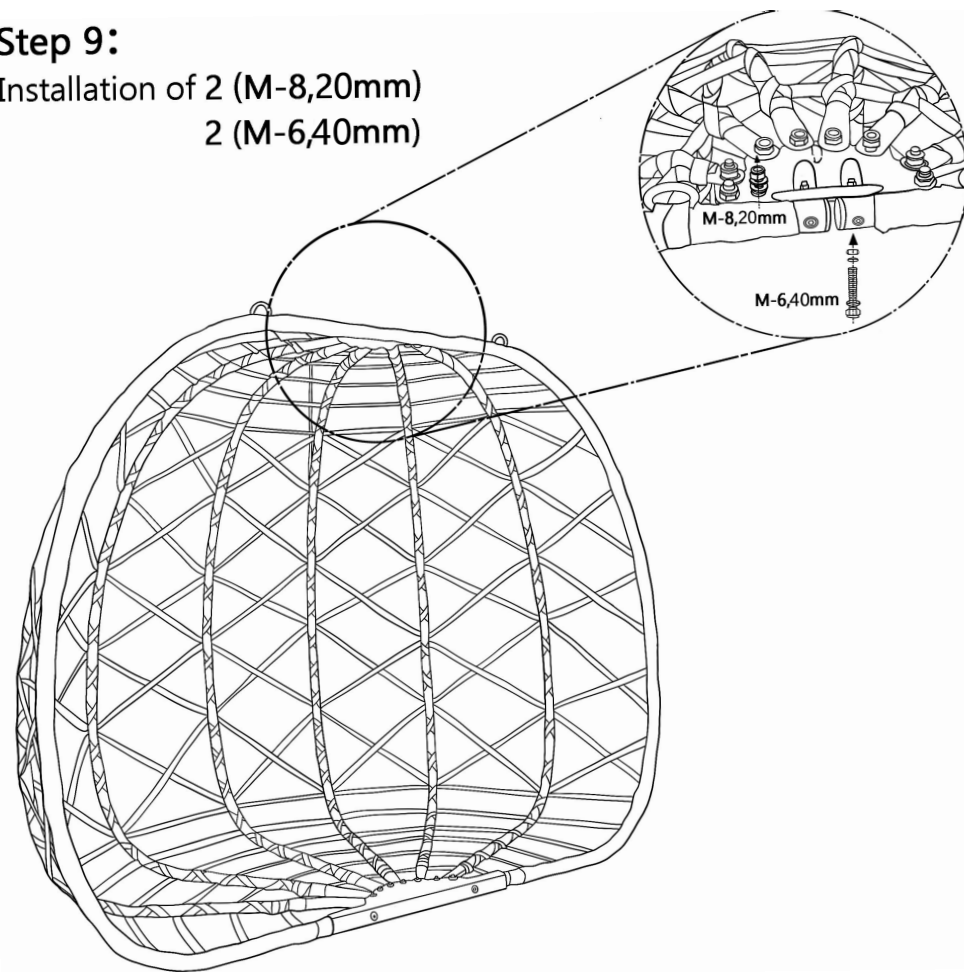

Step 10:

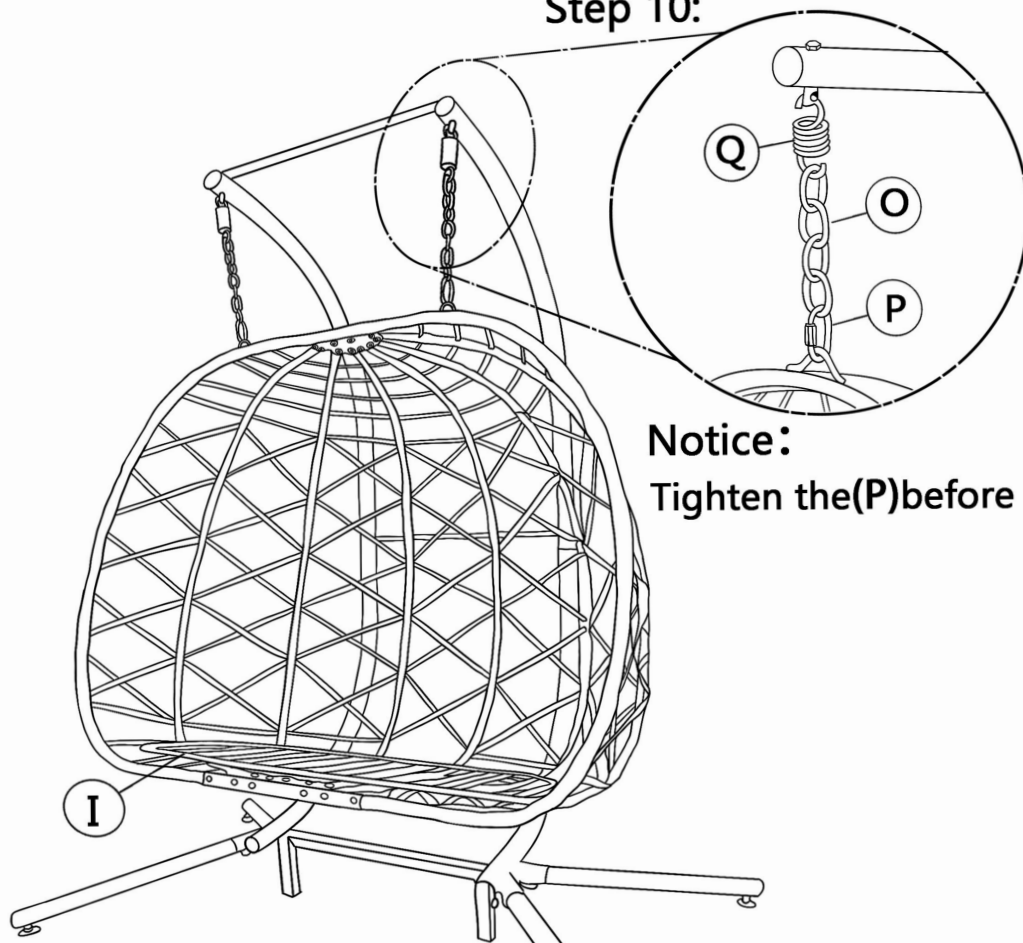

Notice:
Tighten the(P) before use.

Step 11:

Fasten the parts (I) to the base chair (H) with the 6 screws (M-6,50mm)

